

Microprocessor-based weight meter of materials

MS81043P

version 3.1



TECHNICAL DESCRIPTION AND INSTRUCTION FOR
OPERATION

PLOVDIV 2004

I. TECHNICAL DATA

1. Inputs

- 1) analog from sensor for weight
 - linear current 0(4) ÷ 20 mA DC
 - linear voltage 0 ÷ 1(10) V DC
- 2) digital – start of dosing active 0 (0V)
- 3) digital – position of the container NPN or PNP
- 4) digital 2 – selection of memorized parameters for dosing

2. Outputs

- 1) relay 250 V / up to 15 A*
 - K1 rough dosing
 - K2 fine dosing
 - K3 permission for emptying of the container

3. Display

4 digits LED 14 mm

4. Range of the display

-1999 ÷ 9999***

5. Accuracy

±1 LSB

6. Keyboard

folio

7. Overall dimensions (W×H×L)

- 1) horizontal device 96×48×128 mm
- 2) vertical device 48×96×128 mm

8. Installation

panel in a hole 90×44 (44×90) mm

9. Weight

max. 400 g

10. Power supplying voltage

220 V $\frac{10}{15}\%$

11. Frequency of the power supplying voltage

50 Hz (±1 Hz)

12. Operating temperature

0 ÷ 50 °C

13. Operating relative humidity

0 ÷ 80% RH

14. Storage temperature

-10 ÷ 70 °C

15. Storage relative humidity

0 ÷ 95% RH

* - for current over 6 A you have to select other terminals

** - or another value as it is ordered

*** - the formats are X.XXX; XX.XX; XXX.X; XXXX

II. GENERAL APPEARANCE

Front panel

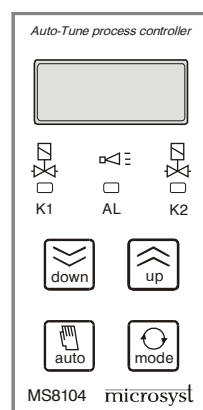

2. Back panel

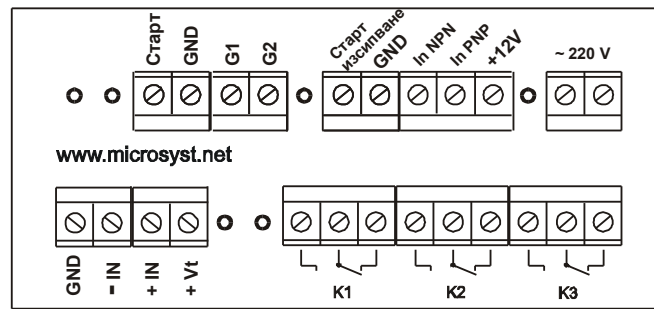

III. OPERATION PRINCIPLE OF THE WEIGHT METER

Before starting of process of dosing by the inputs (G1 and G2) for selection of memorized parameters of dosing you can select the desired set of parameters:

- Maximum possible start weight “**StrE**”
- Weight for dosing “**doSe**”
- Weight of switching fast / slow dosing “**ChnG**”
- Calibrating coefficient “**Corr**”.
- Maximum time for dosing “**tdoS**”.

The controller supports up to 3 sets of memorized parameters (combination of two logic units of the inputs is invalid). In mode “TUNING OF PARAMETERS” you can tune the parameters of the set, selected by the combination of the inputs for selection of sets of parameters. In mode “DOSING” the parameters of the set, which is selected by the combination of inputs for selection of set of parameters, are being used. The controller does not indicate the set of parameters, selected as current. The operator observes that considering the set-pointed combination of the input for selection of set of parameters. The controller has three operating modes (determined by the parameter “**ConF**”).

In mode 0 the following algorithm is valid:

- 1) Check the condition for start: the module of the measured weight must be in the frames of the maximum possible one for a new start (**StrE**) for time “**Strd**”. If the condition is not observed – passes to 2), otherwise error is indicated and waits for observing of the condition.
- 2) Waits for a new start.
- 3) Realizes autotaring, if it is permitted (**AtAr**).
- 4) The controller switches on the output for rough dosing (K1) and if the option rough and fine together (**borF**) is selected – switches on the output for fine dosing (K2), too. The LED **ALL** activates.
- 5) Waits for time for eliminating of the effect from the falling column (**tdth**).
- 6) When reaching the programmed level (**ChnG**) for passing to fine dosing, the output for rough dosing (K1) switches off and the output for fine dosing (K2) activates.
- 7) When reaching the set-pointed dose (“**doSe**” + “**Corr**”) the output for fine dosing (K2) switches off.
- 8) Activates the output (K3) for permission of emptying of the container.
- 9) Waits for time for pouring (**toPn**) or turning of the container (when operating with turning containers) and deactivates the output K3 and the LED **ALL**.
- 10) Passes to 1)

In mode 1 the following algorithm is valid:

- 1) Check the condition for start: the module of the measured weight must be in the frames of the maximum possible one for a new start (**StrE**) for time "**Strd**". If the condition is not observed – passes to 2), otherwise error is indicated and waits for observing of the condition.
- 2) Waits for a new start.
- 3) Realizes autotaring, if it is permitted (**AtAr**).
- 4) The controller switches on the output for rough dosing (K1) and the output for rough dosing (K3) for permission of emptying of the container. If the option rough and fine together (**borF**) is selected, the output for fine dosing (K2) activates, too. The LED **ALL** activates.
- 5) Waits for time for eliminating of the effect from the falling column (**tdth**).
- 6) When reaching the programmed level (**ChnG**) for passing to fine dosing, the output for rough dosing (K1) switches off and the output for fine dosing (K2) activates.
- 7) When reaching the set-pointed dose ("**doSe**" + "**Corr**") the output for fine dosing (K2) switches off.
- 8) Check the condition for start: the module of the measured weight must be in the frames of the maximum possible for a new start (**StrE**) for time "**Strd**". If the condition is observed, the output (K3) deactivates and passes to 9), otherwise waits in this stage till observing of the condition.
- 9) The LED **ALL** deactivates and passes to 1).

In mode 2 the following algorithm is valid:

- 1) Waits for a new start.
- 2) Checks the condition for start: the module of the measured weight must be in the frames of the maximum possible one for a new start (**StrE**) for time "**Strd**". If the condition is observed – passes to 3), otherwise error is indicated and waits for observing of the condition.
- 3) Realizes autotaring, if it is permitted (**AtAr**).
- 4) The controller switches on the output for rough dosing (K1) and if the option rough and fine together (**borF**) is selected, the output for fine dosing (K2) activates, too. The LED **ALL** activates.
- 5) Waits for time for eliminating of the effect from the falling column (**tdth**).
- 6) When reaching the programmed level (**ChnG**) for passing to fine dosing, the output for rough dosing (K1) switches off and the output for fine dosing (K2) activates.
- 7) When reaching the set-pointed dose ("**doSe**" + "**Corr**") the output for fine dosing (K2) switches off.
- 8) Waits for signal "Start pouring".
- 9) Activates the output (K3) for permission of emptying of the container.
- 10) Waits for time for pouring (**toPn**) or turning of the container (when operating with turning containers) and deactivates the output K3 and the LED **ALL**.
- 11) Passes to 1).













The following special features are valid for all modes:

If the dosing is not finished in the programmed time "**tdoS**", the outputs switch off and message about error "**Errt**" appears on the display.

New start is accepted only, if the outer start has passed through inactive level after the end of dosing.

IV. INSTRUCTIONS FOR OPERATION

1. Basic buttons and combinations of buttons

	<p>TARE – By pressing of this button you can tare the device. The read weight is accepted as weight of the tare and the display is reset. The device starts measuring every change of the weight according to the tare in positive (addition) or in negative (subtraction) direction. You can tare the device only, if the device is not in process of dosing.</p>		
	<p>START/STOP – Starting or stopping of the process of dosing. The function of this button is determined according to the current status of the controller (mode measuring or mode dosing).</p> <p>When you press it, the following inscriptions appear:</p> <p>“Strt” – Starting process of dosing. “StOP” – Stopping process of dosing. “FuLL” – Impossible starting of process of dosing. “FuLL” appears in the following cases:</p> <p>A) The container is not empty from the previous dosing (the measured weight is more than the maximum possible for a new start). B) The weight of the tare together with the weight for dosing exceeds the maximum weight, measured by the sensor.</p>		
		<p>UP and TARE – In the time, while these buttons are pressed, the value of the weight of the tare appears.</p>	
		<p>DOWN and START/STOP – In the time, while these buttons are pressed, the number of the realized dosing up to the moment of the last resetting of the counter appears on the display.</p>	
			<p>DOWNS, START/STOP and UP – By the addition of the button UP to the previous combination you can reset the counter of the dosings.</p>
		<p>DOWN and TARE – By this combination you can enter mode “CALIBRATION” – calibration of the device.</p> <p>While these buttons are pressed “CALL” appears on the display.</p> <p>The calibration can be done as it follows:</p> <ol style="list-style-type: none"> 1. Realize taring. 2. Put a standard weight. 3. Wait for stabilization of the indication on the display. 4. Enter mode “CALIBRATION”. 5. By the pointers correct the value on the display according to the standard weight. 6. Press the button “TARE” for confirmation. <p>You can exit mode “CALIBRATION” automatically by non-pressing of a button for more than 3 sec, and the changed value is memorized.</p>	
		<p>UP and DOWN – By simultaneous pressing of these two buttons you have access to mode “TUNING OF PARAMETERS”. While these buttons are pressed “tune” appears on the display.</p>	

2. Mode “TUNING OF PARAMETERS”

The tuning of the parameters can be done by the buttons **UP** and **DOWN** for change and the button **TARE** for confirmation.

“doSE”	Weight for dosing. Dimension and decimal point according to the maximum measured weight and the resolution of the sensor.
“ChnG”	Weight of switching from rough to fine dosing. Dimension and decimal point according to the weight for dosing.
“StrE”	Maximum possible weight for a new start (remaining weight in the container). At value 0 the check is forbidden.
“Corr”	Correction , made by the weight meter because of the remaining weight, entering the container after switching off of the fine dosing and because of the error of the hesitation of the system. You have to consider that the so entered value for the error is added to the set-point for dosing, i.e. if the controller doses less, this value is increased and if it doses more, this value is decreased.
“tdoS”	Maximum time for dosing. If till its running out the dosing is not finished, the process is stopped and “Errt” appears flashing. It disappears, if you press any button or a new start. At value of the parameter 0 the time switches off i.e. there is no limit of the time of dosing. Dimension: 0... 120 sec.
“Strd”	Time for stabilization of the weight under the maximum possible for new start. The time is being waited for always, not depending on that if the check for maximum possible weight for a new start is activated or forbidden. Dimension: 0.0... 20.0 sec.
“toPn”	Time for pouring of the container. This parameter has meaning only in modes 0 and 2. Dimension: 0.0... 20.0 sec.

After tuning of the last parameter “End” appears on the display. By pressing of a button different from **TARE** you can pass to second tuning of the parameters from the beginning. By pressing of **TARE** you can exit the mode for tuning.

3. LEDs

The controller has three LEDs – **K1**, **K2** and **ALL**. The LEDs **K1** and **K2** emit light at switched off outputs for rough and fine dosing.

4. Messages about errors

The controller indicates the following messages about errors:

- A) “**ErrE**” – error when saving or reading from EEPROM.
- B) “**Errt**” – the maximum time for dosing has run out. The inscription is flashing, alternating with the value of the current weight. The error can be cleared by pressing of any button or by a new start.
- C) “**ErrG**” – incorrect combination of the inputs for selection of memorized dosing. It is necessary to check the connection of the switch with the device.
- D) “**ErrU**” – the weight of the tare together with the set-pointed value of the weight for dosing exceed the maximum weight, measured by the sensor.

V. OTHER POSSIBILITIES OF THE WEIGHT METER

The controller realizes automatic reading of the number of realized dosings, memorizing them in EEPROM. A finished dosing is considered this one, which has finished normally, i.e. without pressing of the button **START/STOP** or running out of the time for dosing.

You can reset the number of dosings by the combination of the buttons **DOWN**, **START/STOP** and **UP**.

VI. SYSTEM PARAMETERS OF THE WEIGHT METER

The system parameters are accessible at pressed buttons UP and DOWN when switching on the power supply.

“A0”	Multiplying coefficient for linearization of the sensor. (It is being calculated automatically in mode of calibration)	Dimension: ± 9999 (1024th)
“A1”	Free member for linearization of the sensor.	Dimension: ± 9999
“dPnt”	Position of the decimal point - 0.000, 00.00, 000.0 and 0000	Dimension: 0... 3
“TeGL”	Maximum measured weight by the sensor.	
“tdth”	Time, in which indications are not being read, it is started after activation of the process of dosing. Dimension: 0... 20.0 sec.	
“ConF”	Selection of operating mode of the output: 0, 1 or 2	
“borF”	Option 0 – During rough dosing only the output for rough dosing is activated 1 – During rough dosing the outputs for rough and fine dosing are activated	
“AtAr”	Autotaring: 0 – forbidden 1 – permitted	
“rotC”	Operation with turning containers 0 – forbidden 1 – permitted	
“AvrF”*	Average filter.	Dimension: 1... 5
“E Fr”**	Exponential filter.	Dimension: 1... 5
“FrJS”	Filter jump of clearing in percents of the range.	Dimension: 0.1... 100.0
“dtFt”	Time for jump of the filter	Dimension: 0.00... 2.00 sec.

After exit from this mode the tare is reset.

* The values of the parameter from 1 to 5 correspond to average sums of 1, 2, 4, 8, 16 consecutive measurements.

** The bigger is the value, the deeper is the filter.

Bulgaria, 4000 Plovdiv, 4 Murgash str.

Tel.: (+359 32) 642 519, 640 446 Fax: (+359 32) 640 446

www.microsyst.net e-mail: info@microsyst.net